



SEGNALETICA  
VISUAL SIGNS





# I N D I C E

INDEX

**4** S E G N A L E T I C A  
INTERIOR SIGNAGE

---

**16** T O T E M  
TOTEM

---

**20** C O R N I C I  
SNAP FRAME

---

**24** L A V A G N E  
M A G N E T I C H E  
MAGNETIC BOARDS

---

**28** B A C H E C H E  
LOCKABLE NOTICE BOARDS

---

**32** C O L O N N I N E  
S E G N A P E R C O R S O  
CROWD CONTROL POSTS SYSTEM

---

**42** P A N N E L L I  
D I V I S O R I  
DIVIDING PANELS

---

**44** E S P O S I T O R I  
P O R T A D E P L I A N T  
LITERATURE STANDS

---

**50** P O R T A  
T A B L E T  
TABLET STANDS

---



## SEGNALETICA S1 PER INTERNI INTERIOR SIGNAGE SYSTEM S1



Foglio di protezione in PVC trasparente  
Non-glare transparent PVC cover

Stampa digitale  
Digital printing

Fondo in lamiera  
Back metal panel

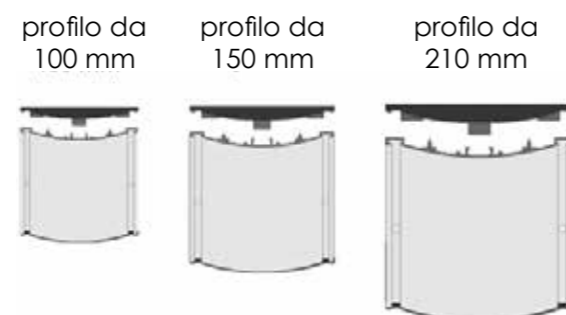

**Fissaggio** a parete con kit in dotazione composto di viti e tasselli, o con biadesivo.  
**Wall fixing** with supplied kit with screws and dowels, or with double adhesive tape.

## SEGNALETICA S1 PER ESTERNI OUTDOOR SIGNAGE SYSTEM S1



Foglio in lamiera  
Metal panel

Fondo in lamiera  
Back metal panel

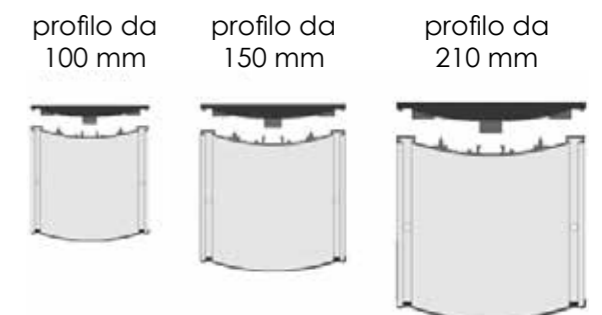

**Fissaggio** a parete con kit in dotazione composto di viti e tasselli, o con biadesivo.  
**Wall fixing** with supplied kit with screws and dowels, or with double adhesive tape.



## SEGNALETICA S1 A BANDIERA FLAG SIGNAGE SYSTEM S1

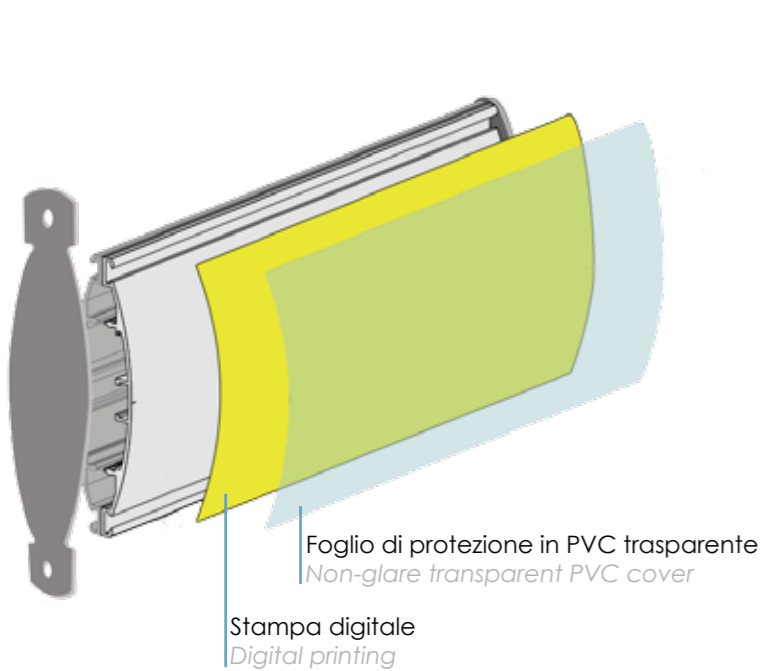

profilo da 100 mm    profilo da 150 mm    profilo da 210 mm

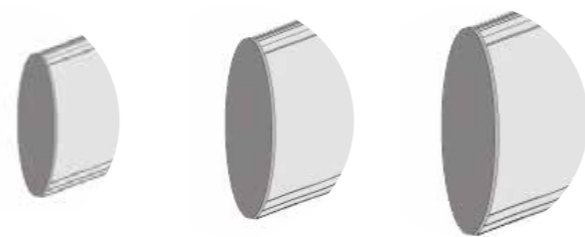

**Fissaggio** a parete con kit in dotazione composto di tasselli e viti a vista.

**Wall fixing** with supplied kit with dowels and screws in view.



## SEGNALETICA S1 A BANDIERA FLAG SIGNAGE SYSTEM S1

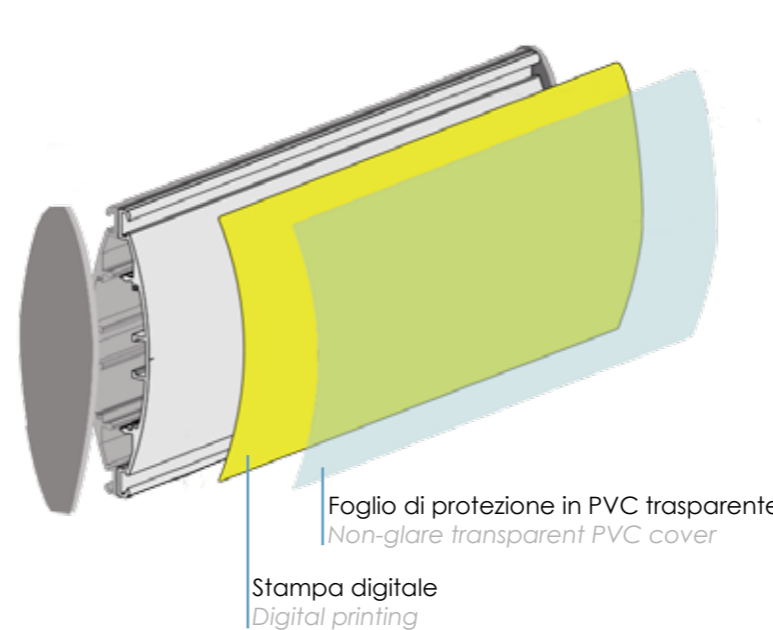

profilo da 100 mm    profilo da 150 mm    profilo da 210 mm

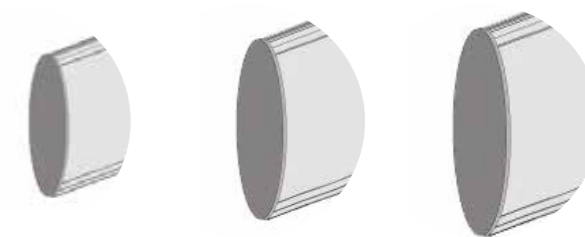

**Fissaggio** a parete con kit in dotazione composto di viti e tasselli.

**Wall fixing** with supplied kit with screws and dowels.



## SEGNALETICA S1 A SOFFITTO

### SUSPENSION SIGNAGE SYSTEM S1

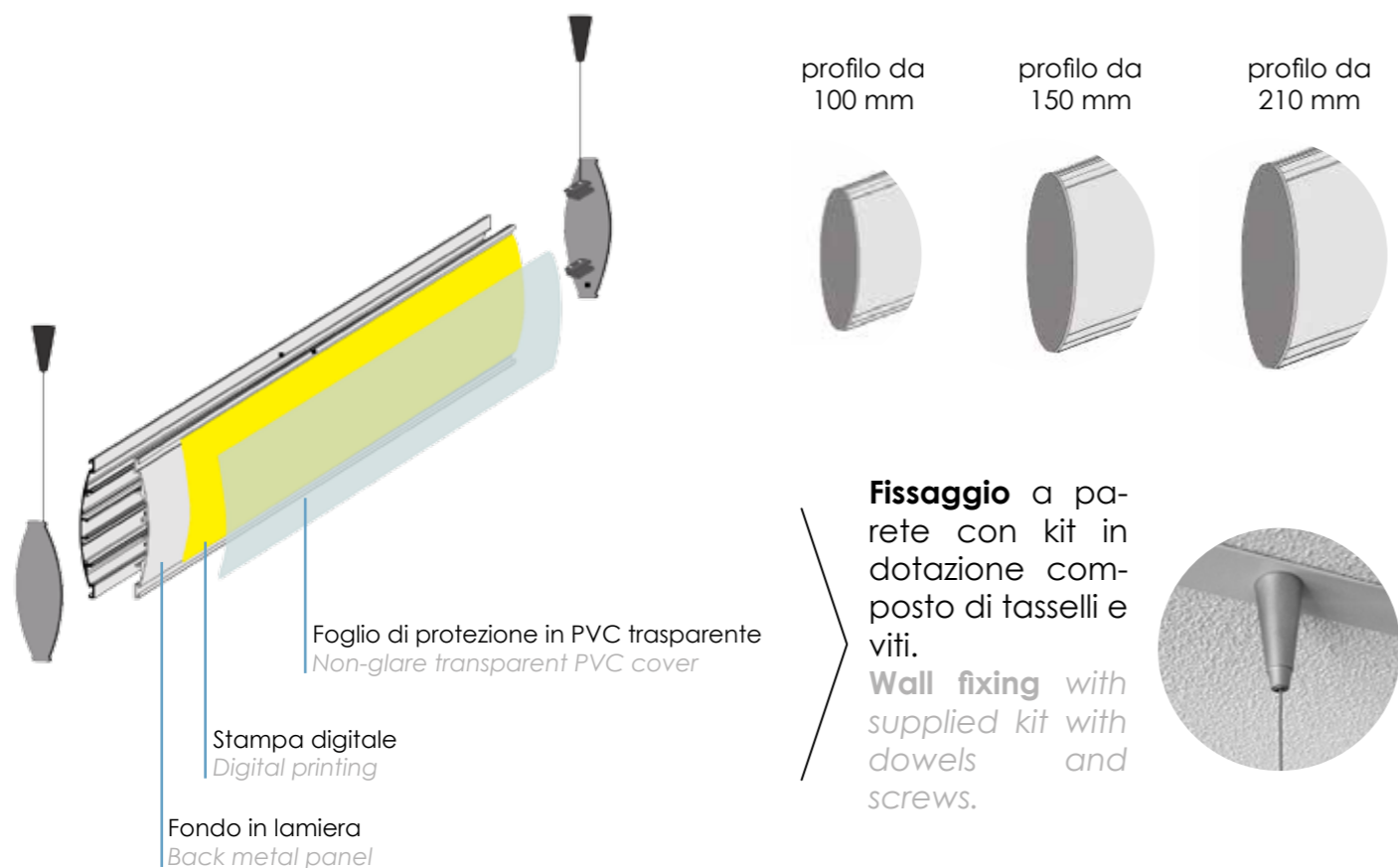

## PANNELLI SEGNALETICI S2

### SIGNS PANELS SYSTEM S2

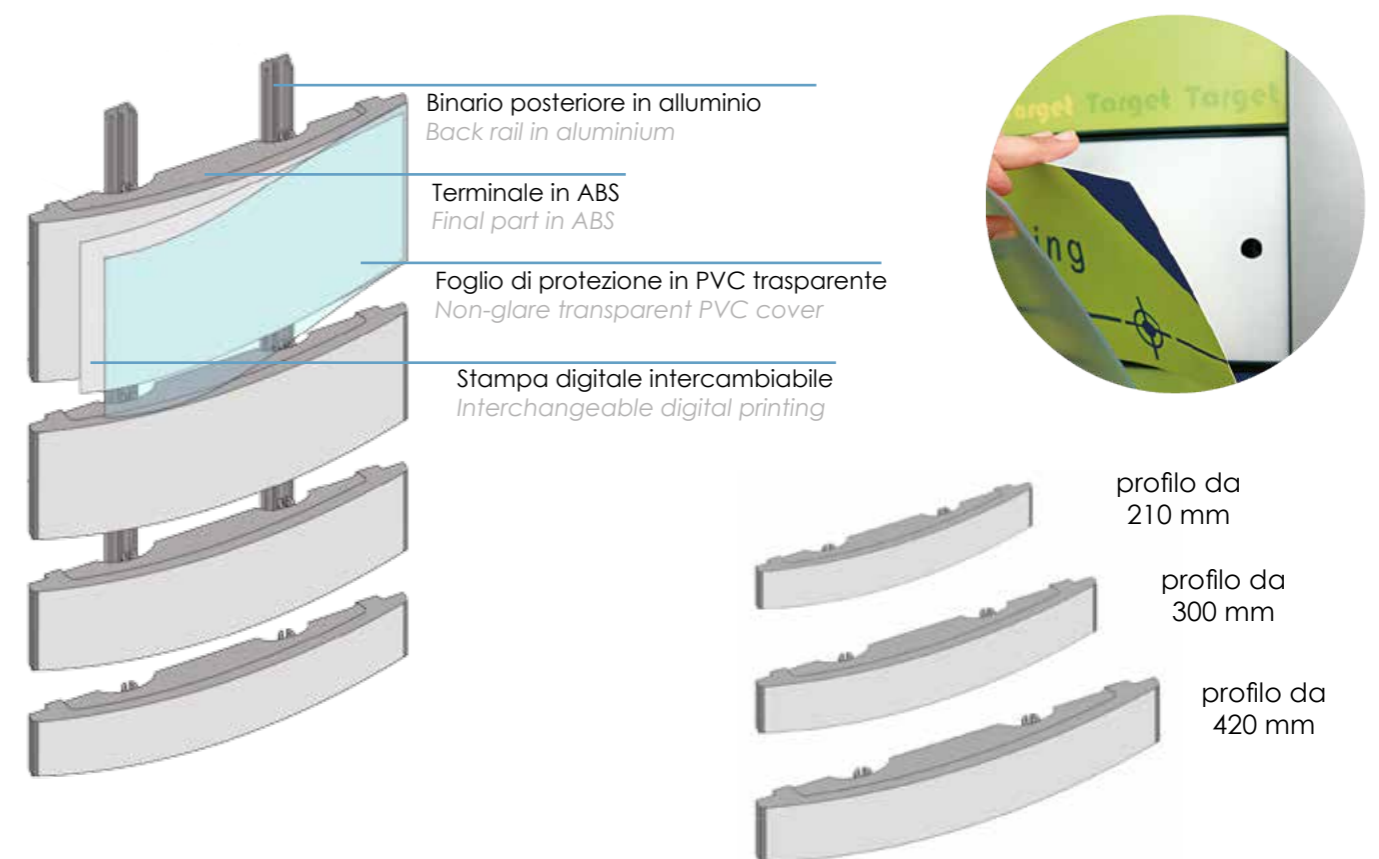

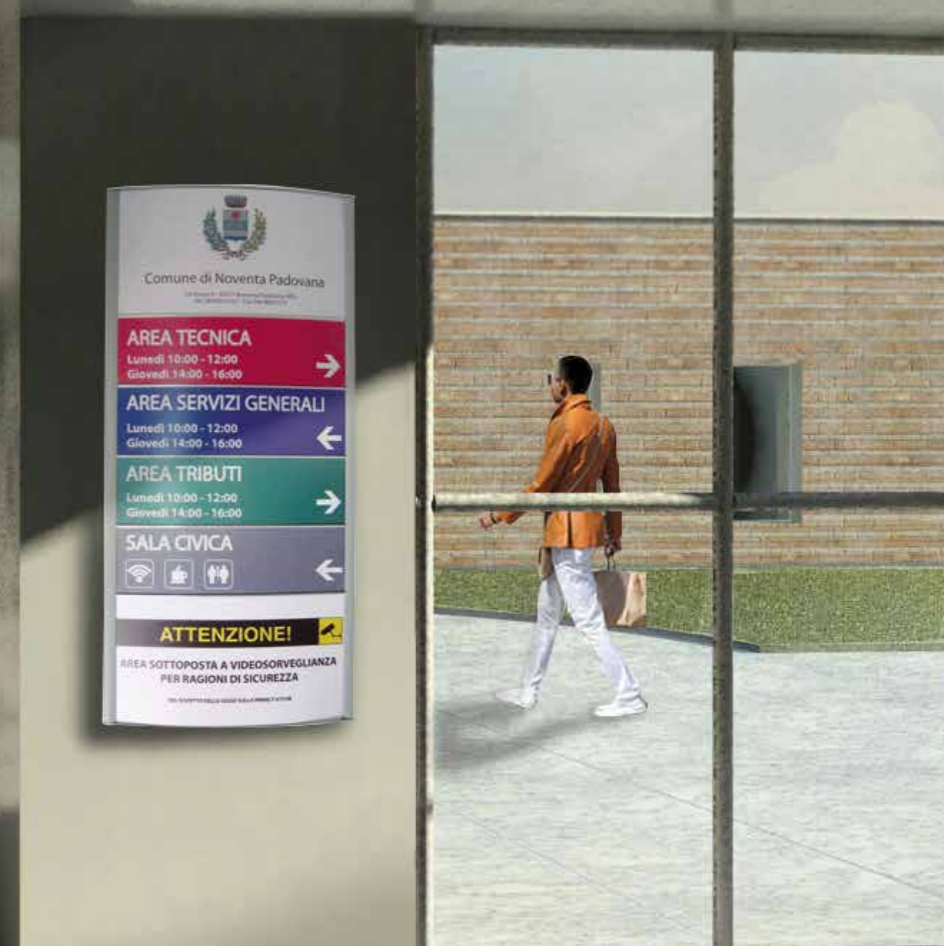

## SEGNALETICA S3 GRANDI FORMATI PER ESTERNI

### OUTDOOR LARGE FORMAT SIGNAGE SYSTEM S3

## SEGNALETICA S3 GRANDI FORMATI PER INTERNI

### INTERIOR LARGE FORMAT SIGNAGE SYSTEM S3

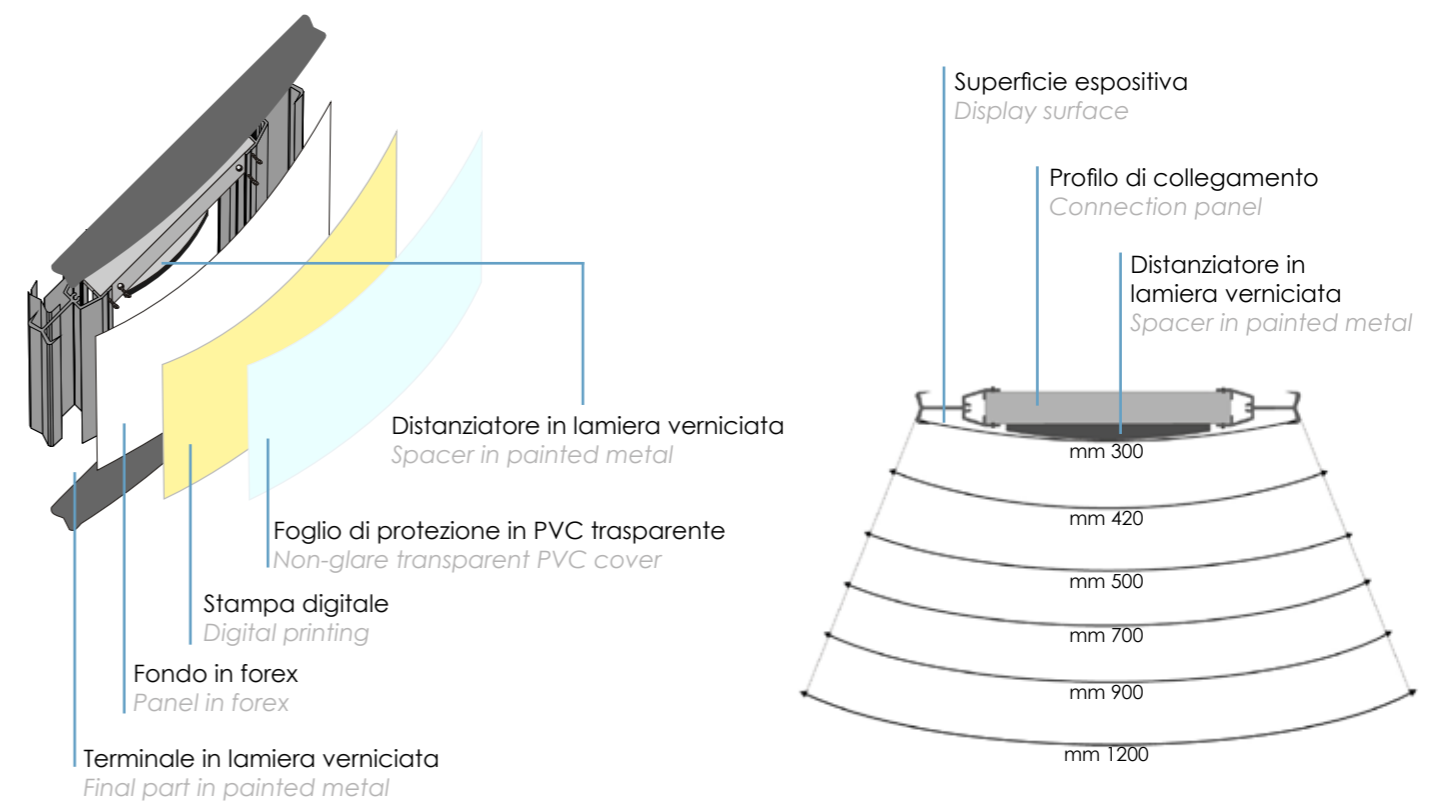
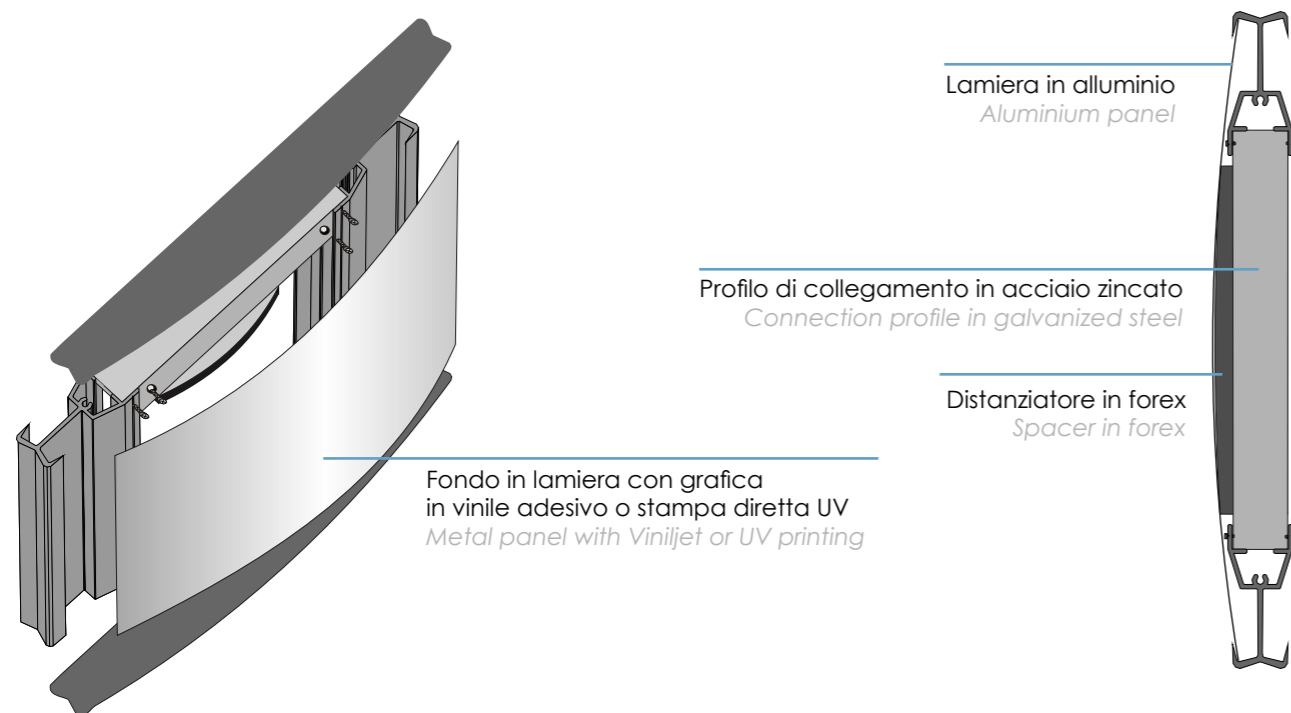



# DIMENSIONI - DIMENSIONS

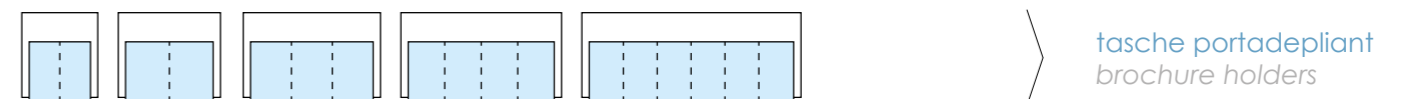
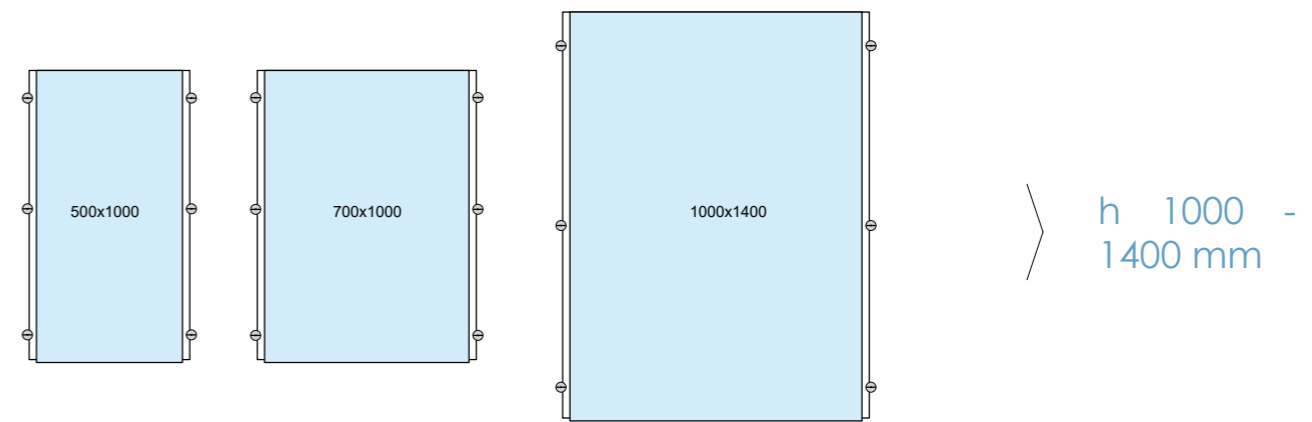
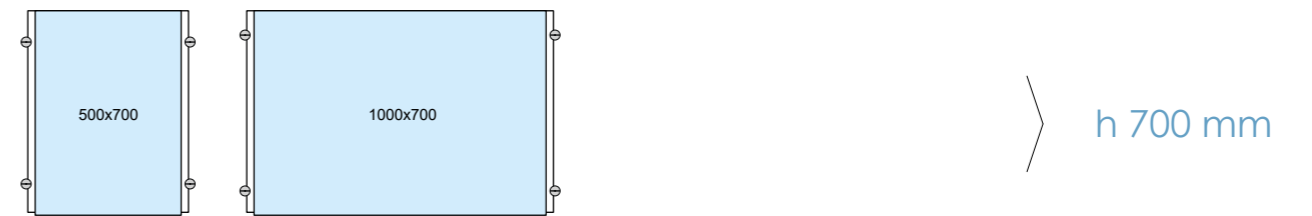
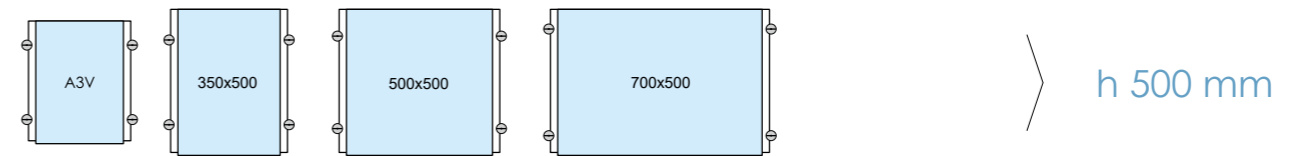
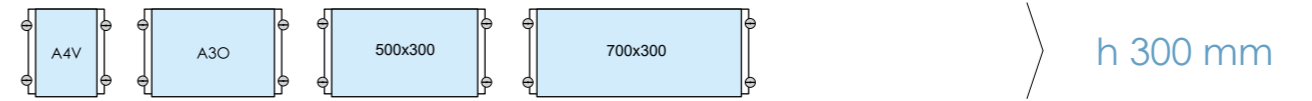
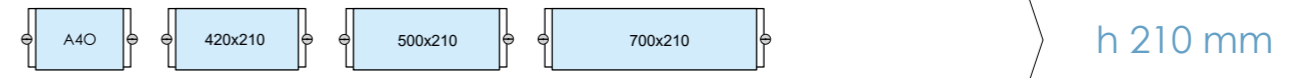
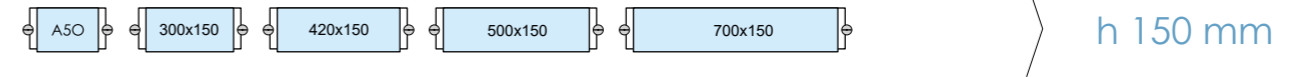

## SEGNALETICA P1 SIGNAGE SYSTEM P1

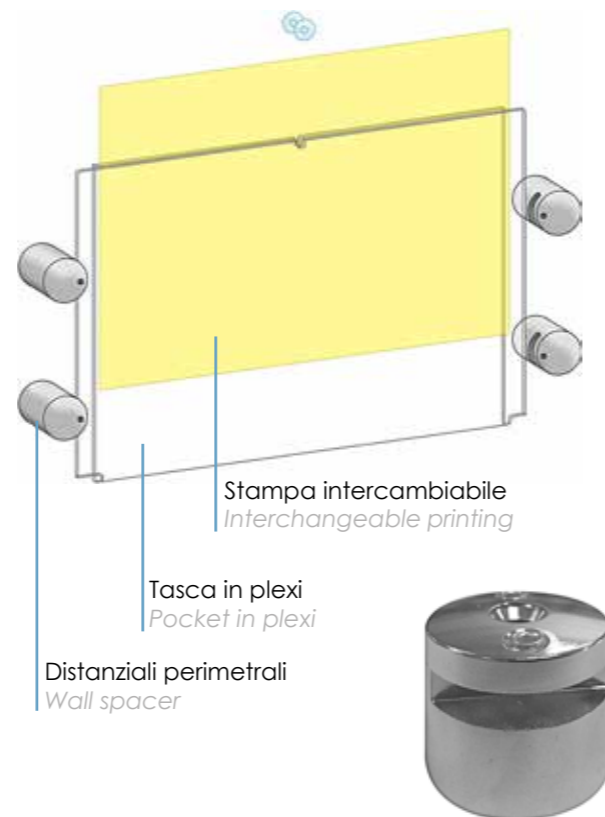



## SEGNALETICA P1 SIGNAGE SYSTEM P1

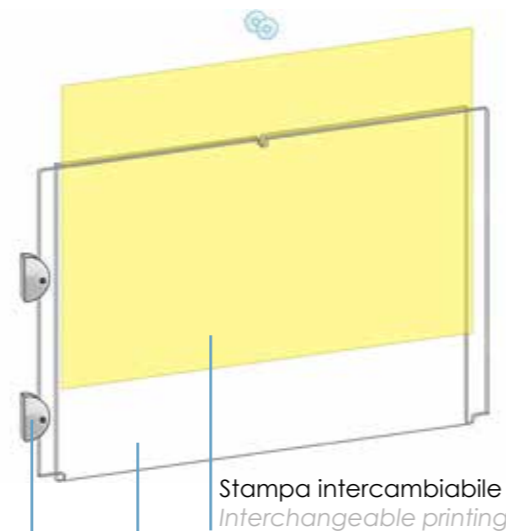
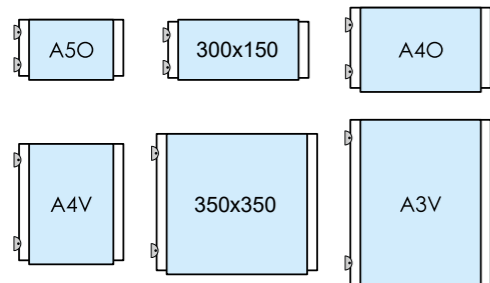

## SEGNALETICA P1 SIGNAGE SYSTEM P1

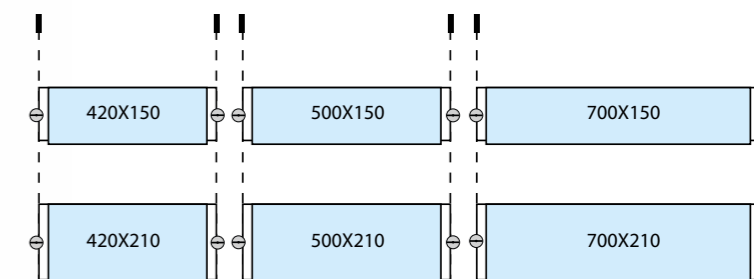





## MINITOTEM PER INTERNI INDOOR MINITOTEM

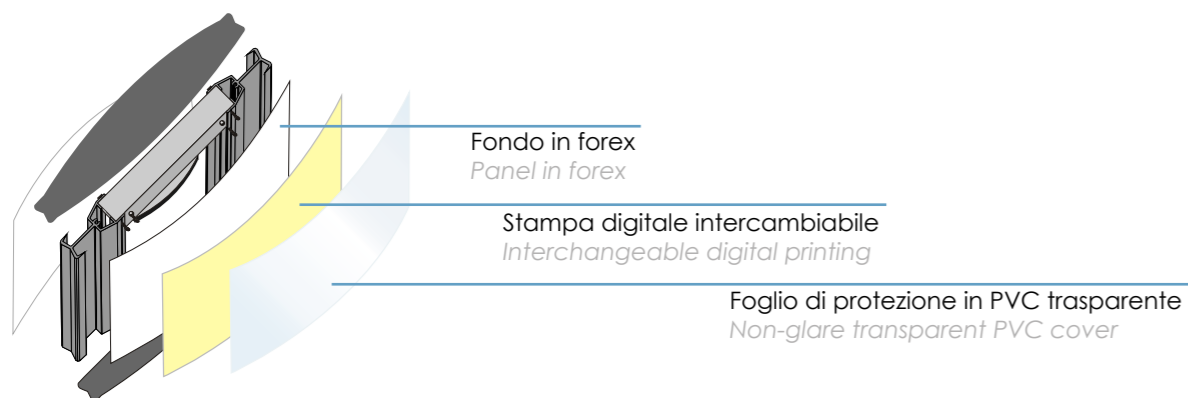

**Dimensioni** applicate sia alla versione per interni che per esterni.  
*Dimensions applied to both indoor use and outdoor use.*

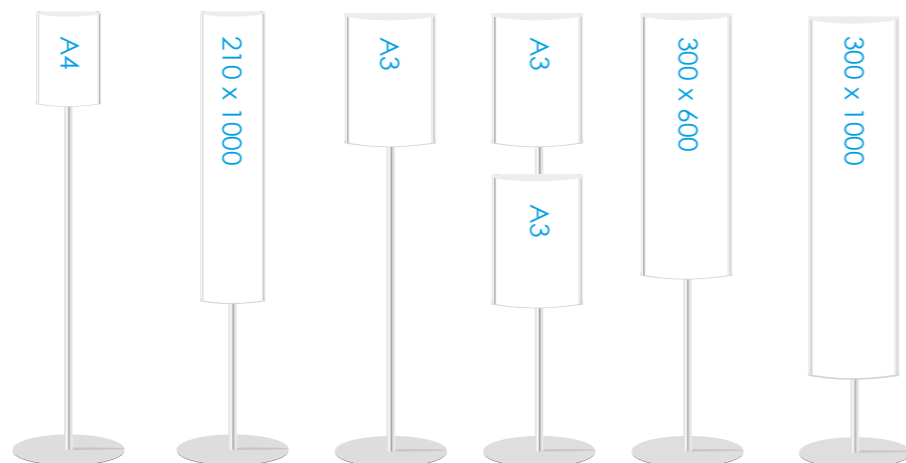

## MINITOTEM PER ESTERNI OUTDOOR MINITOTEM

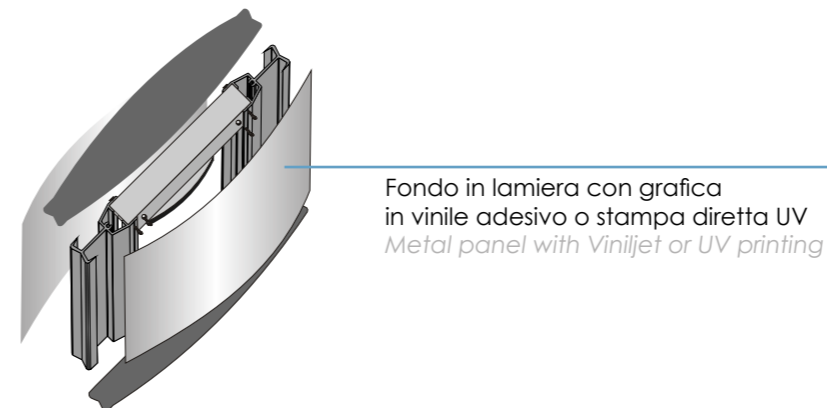

**Dimensioni** applicate sia alla versione per interni che per esterni.  
*Dimensions applied to both indoor use and outdoor use.*

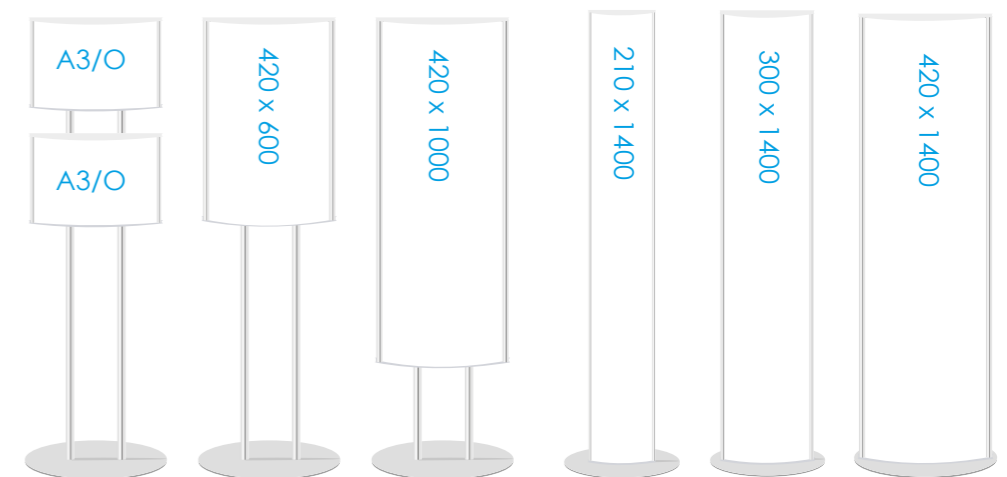



# TOTEM PER INTERNI INDOOR TOTEM

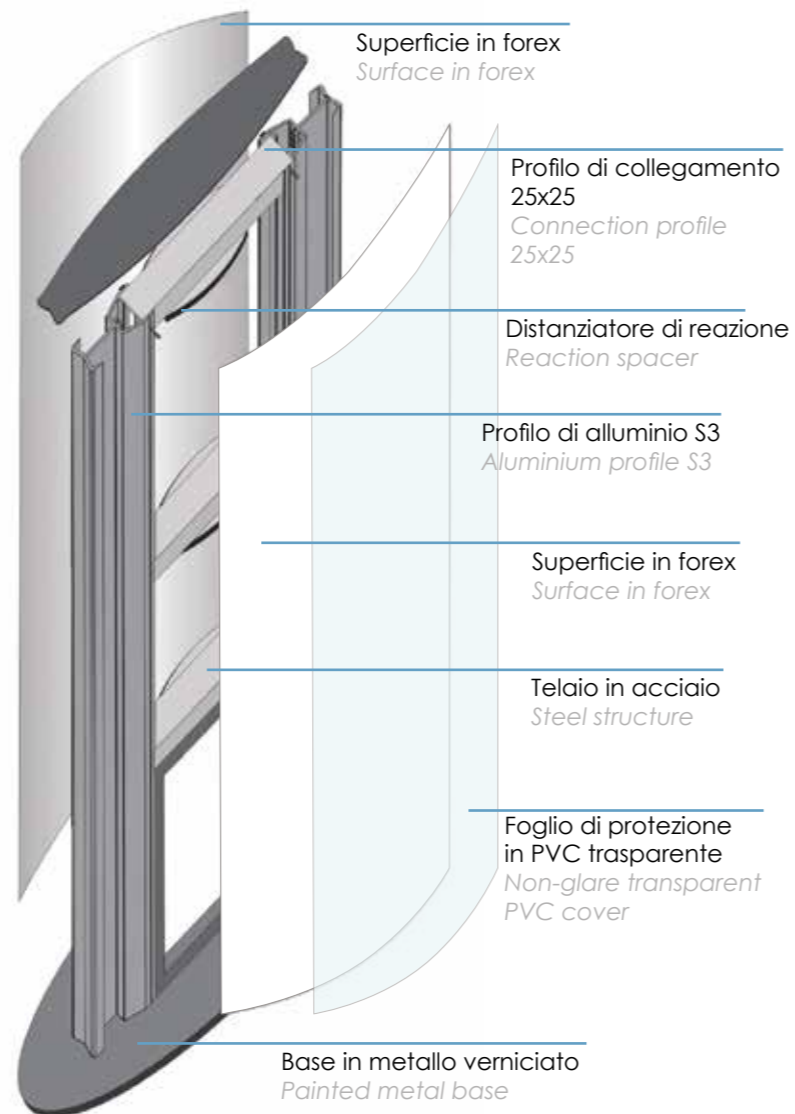

# TOTEM PER ESTERNI OUTDOOR TOTEM





## CORNICI A SCATTO SNAP FRAME



Stampa intercambiabile  
Interchangeable printing



## CORNICI MAGNETICHE



Stampa intercambiabile  
Interchangeable printing





## DIMENSIONI - DIMENSIONS

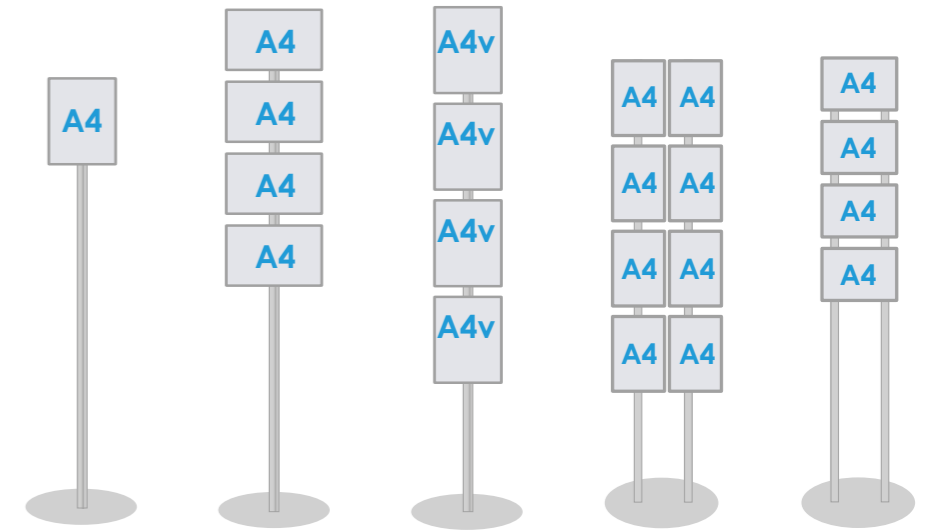

## CORNICI A SCATTO AUTOPORTANTI SNAP FRAME STAND

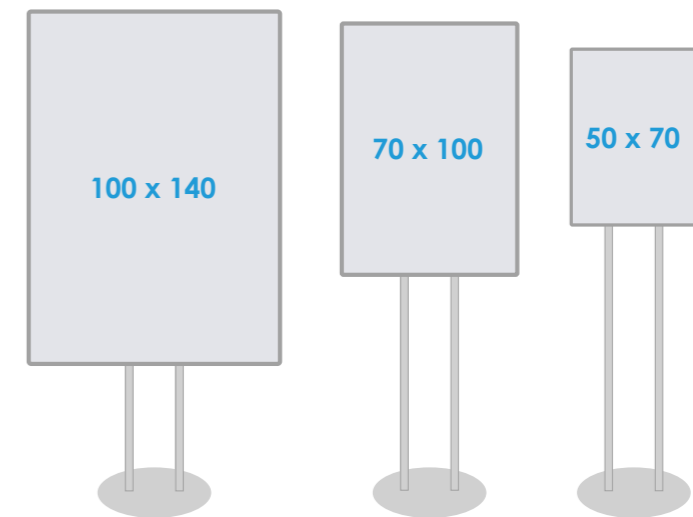
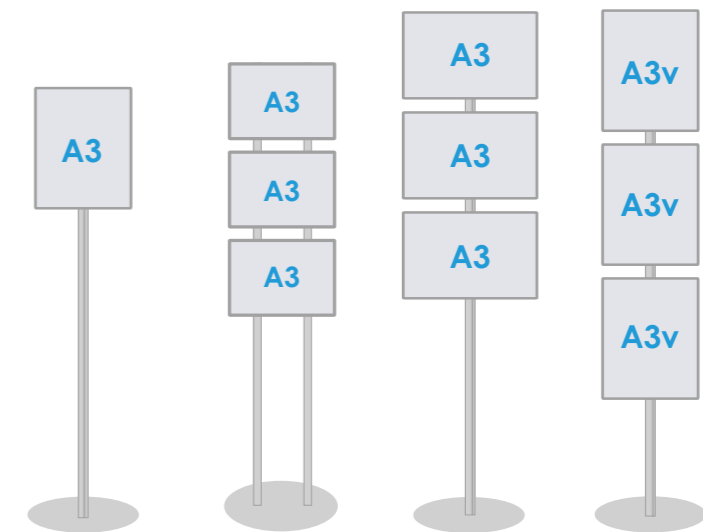

**Cornici a scatto autoportanti** con montante in alluminio anodizzato, base in metallo color silver. Foglio di protezione in PVC antiriflesso. Versione mono o bifacciale.  
**Snap frame stand** with anodized aluminum poles, metal base in silver colour. FAnti-glare PVC front foil. Available in one side or two-side version.

# LAVAGNA MAGNETICA

## MAGNETIC BOARD

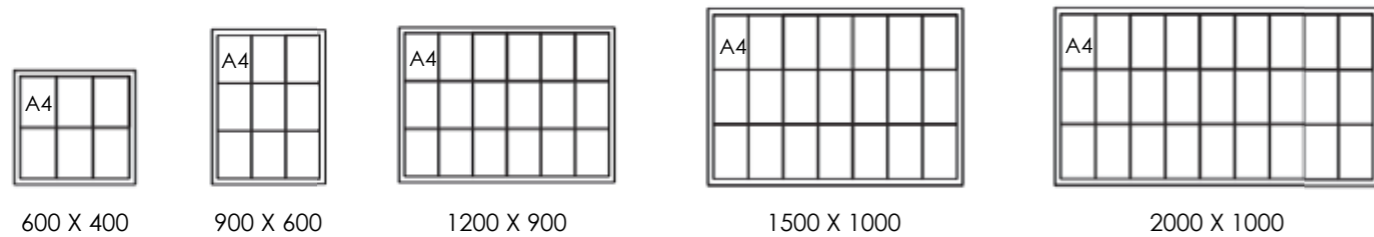

Lavagna magnetica scrivibile in acciaio laccato. Cornice in alluminio anodizzato silver. Materiale per il fissaggio incluso. Posizionabile in orizzontale o verticale.

*Writable magnetic board in high quality steel. Silver anodised aluminium frame. Fixing material included. Suitable for either mounting in portrait or landscape orientation.*

# LAVAGNA IN SUGHERO

## NATURAL CORK BOARD

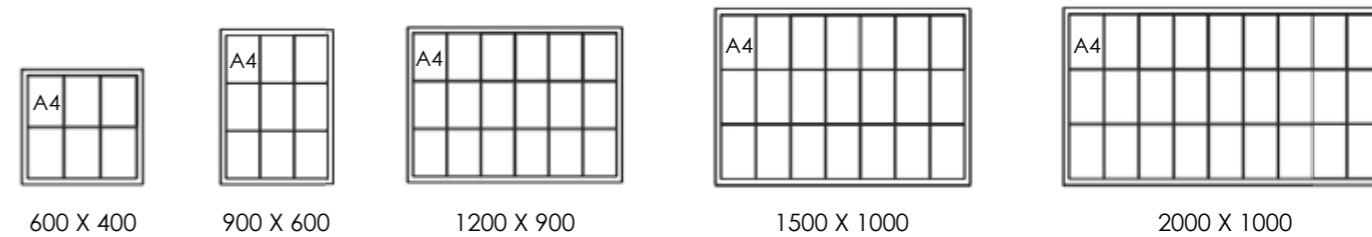
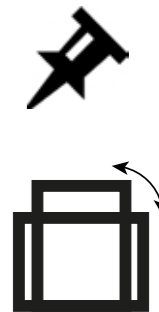

Lavagna in sughero naturale da utilizzare con puntine fermafogli. Cornice in alluminio anodizzato silver. Materiale per il fissaggio incluso. Posizionabile in orizzontale o verticale.

*Board in natural cork for use with pins. Silver anodised aluminium frame. Fixing material included. Suitable for either mounting in portrait or landscape orientation.*



## LAVAGNE AUTOPORTANTI FREE-STANDING BOARDS

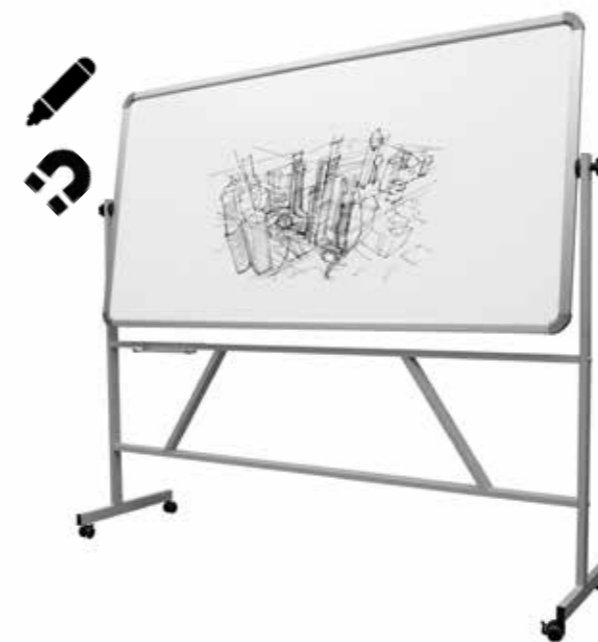
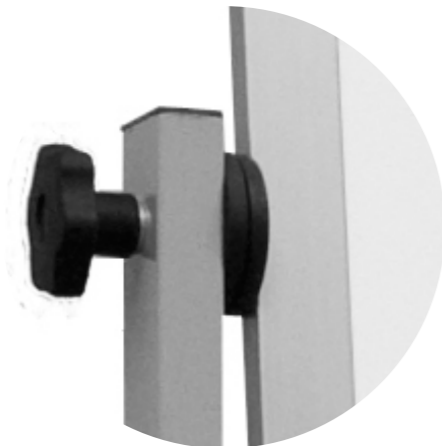

Lavagna con doppia superficie in acciaio porcellanato, ruotabile a 360°. Cavalletto smontabile in alluminio anodizzato silver completo di ruote.

*Double board surface in white steel porcelain, 360° rotatable. Anodized aluminium removable stand in silver colour with castors.*

Lavagna portablocco con superficie in acciaio laccato scrivibile e magnetico. Altezza regolabile fino a 190 cm.

*Flipchart easel with magnetic and writable surface in steel lacquered. Adjustable height to 190 cm.*



Lavagna portablocco con superficie in acciaio laccato scrivibile e magnetico. Struttura di sostegno regolabile fino a 220 cm con base carrellata.

*Flipchart easel with magnetic and writable surface in steel lacquered. Adjustable structure to 220 cm with castors.*

# BACHECA PER INTERNI APERTURA A LIBRO INDOOR LOCKABLE NOTICE BOARD

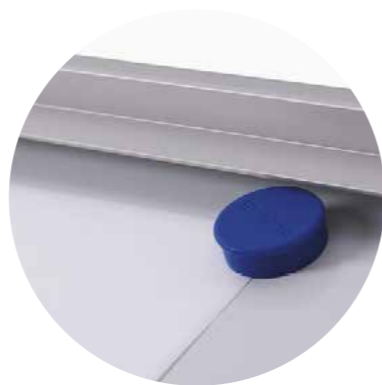

Bacheca magnetica scrivibile con struttura in alluminio anodizzato. Anta trasparente in materiale acrilico, apertura a libro. Chiusura con serratura. Materiale per il fissaggio incluso.  
*Writable magnetic notice board with anodised aluminium frame. Door in transparent plexiglass, opens like a book. Cylinder lock. Fixing material included.*

# BACHECA PER INTERNI APERTURA SCORREVOLE INDOOR SLIDING DOOR LOCKABLE NOTICE BOARD

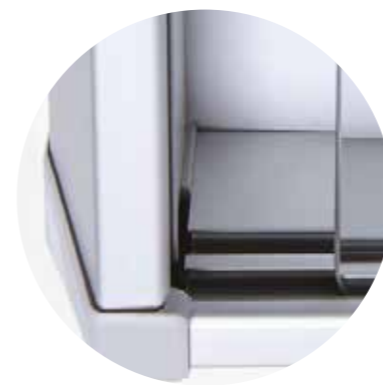

Bacheca magnetica scrivibile o in sughero naturale con struttura in alluminio anodizzato. Ante trasparenti in materiale acrilico, apertura scorrevole. Chiusura con serratura. Materiale per il fissaggio incluso.  
*Notice board magnetic and writable or in natural cork for use with pins. Silver anodised aluminium frame. Sliding door in transparent plexiglass. Cylinder lock. Fixing material included.*



MCCOY



# BACHECA PER ESTERNI CERTIFICATA IP56

## OUTDOOR LOCKABLE NOTICE BOARD CERTIFICATED IP56



Set di due montanti in alluminio anodizzato per l'esposizione della bacheca all'esterno  
Set of 2 aluminium profile posts for outdoor use

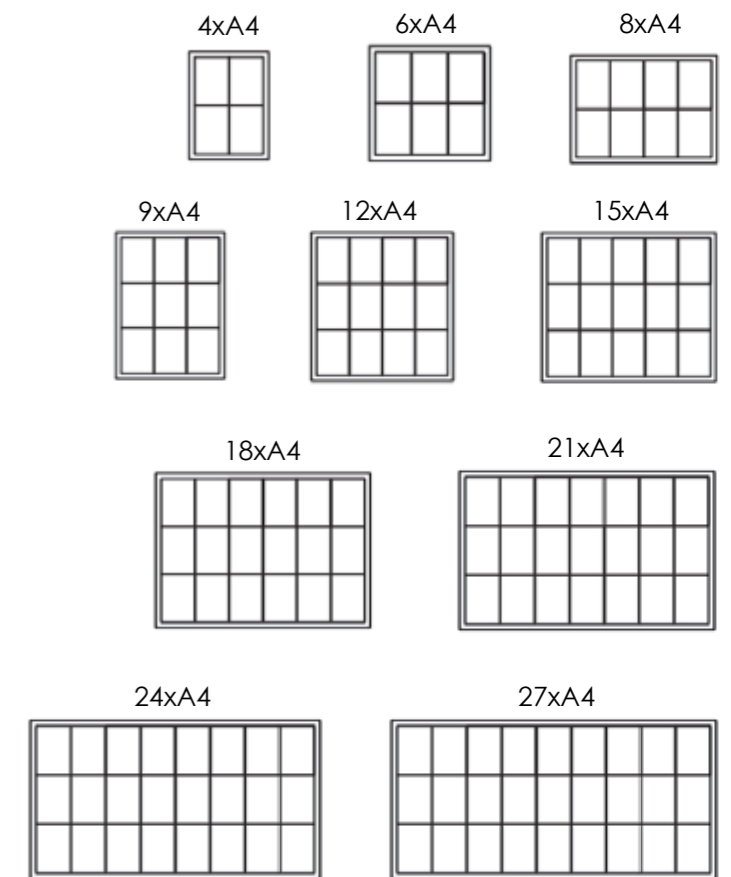
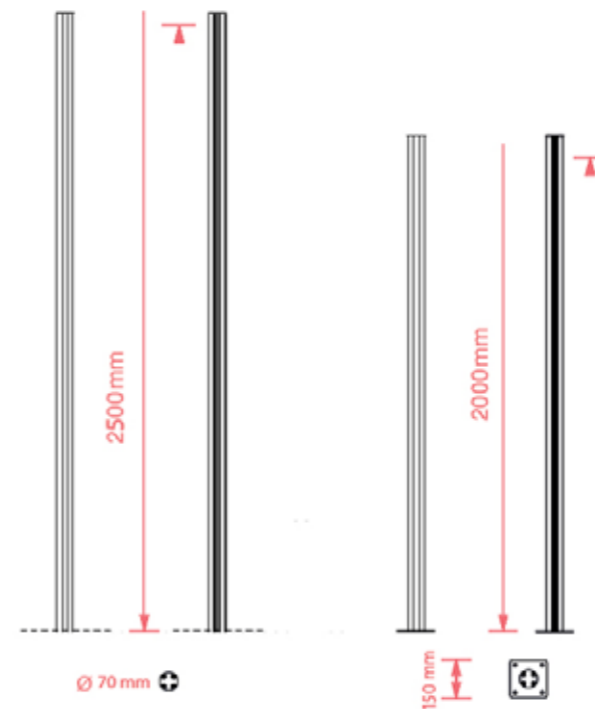



# COLONNINE SEGNAPERCORSO CROWDCONTROL POSTS SYSTEM

Colonnine tendinastro con finitura acciaio spazzolato o nero satinato. Altezza 100 cm. Peso totale kg 10. Lunghezza nastro 3 m.  
*Stainless steel posts brushed finishes or black painted. Overall height 100 cm. Total weight kg 10. Retractable belt 3 m long.*





**Colonnina tendinastro  
in acciaio spazzolato**

*Stainless steel crowd control  
posts system*

Colori nastro: blu, rosso, nero,  
bianco, giallo/nero, bianco/  
rosso, verde. Altri colori su ri-  
chiesta.

*Belt colors: blue, red, black,  
white, yellow/black, white/  
red, green. Other colors on  
request.*

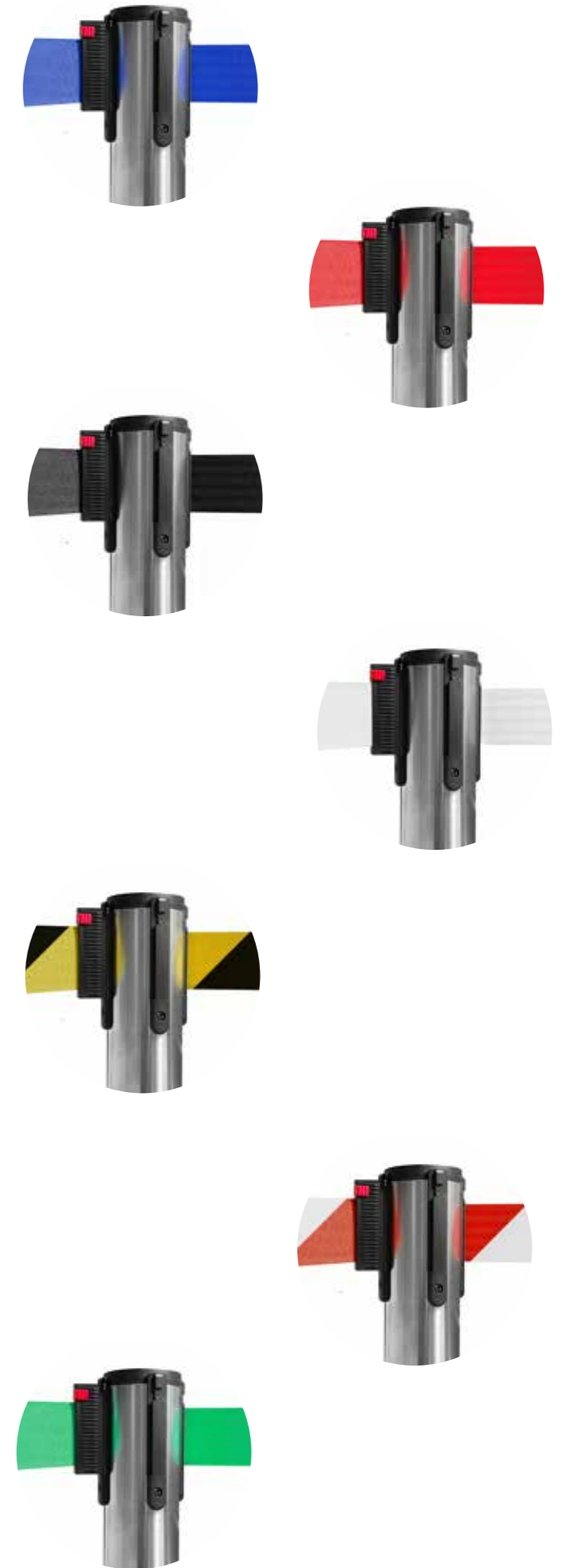
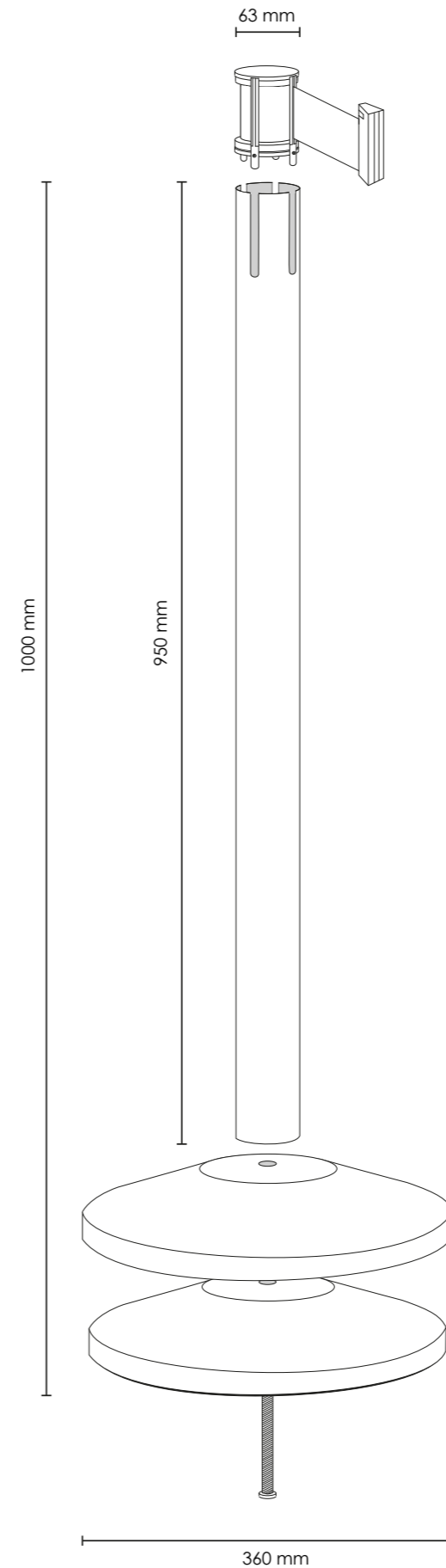



**Colonnina tendinastro  
color nero satinato**

*Black crowd control posts  
system*

Colori nastro: blu, rosso, nero,  
bianco, giallo/nero, bianco/  
rosso, verde. Altri colori su ri-  
chiesta.

*Belt colors: blue, red, black,  
white, yellow/black, white/  
red, green. Other colors on  
request.*

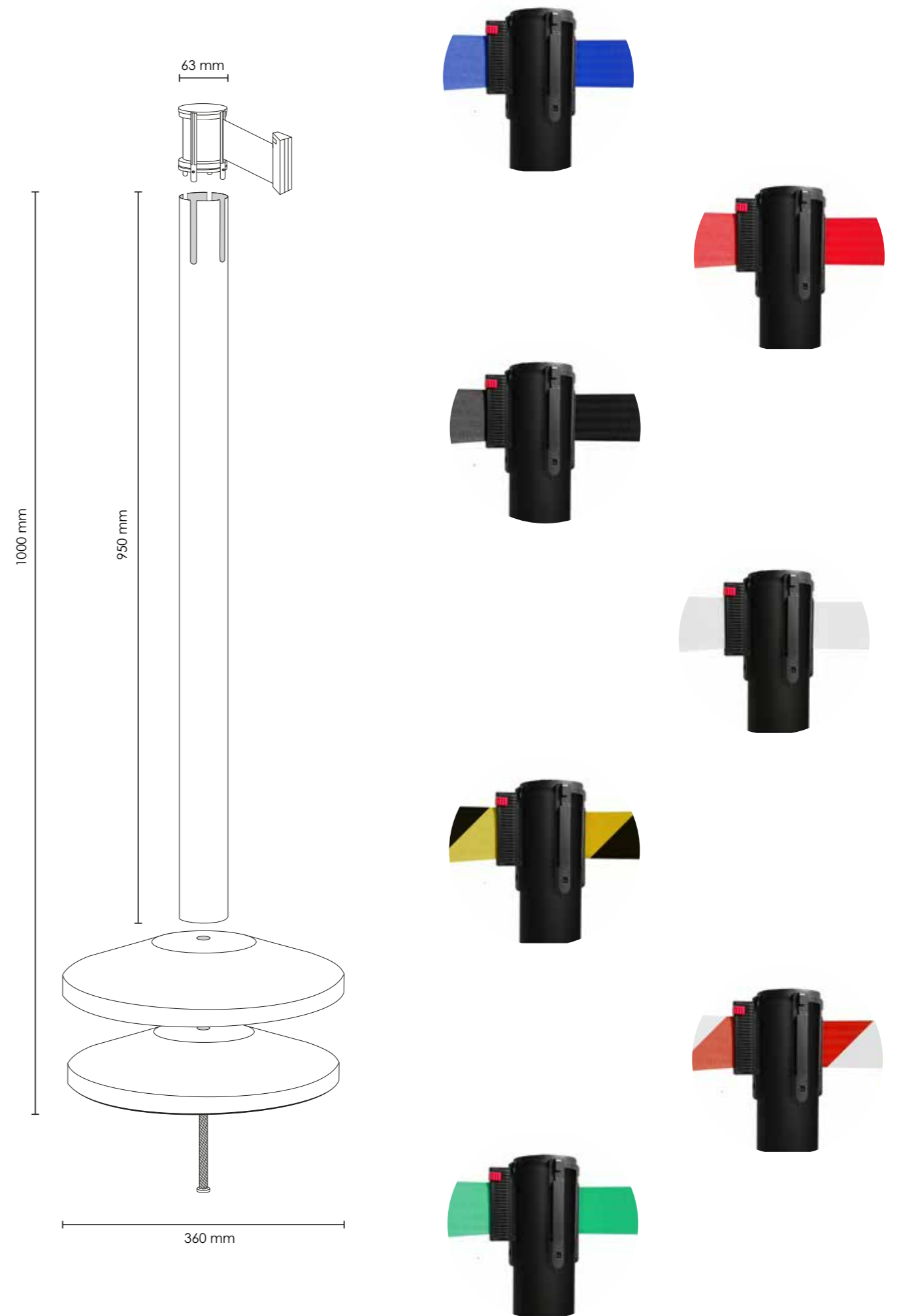



Attacchi a muro verniciato nero opaco con nastro da 3 o 4 metri.  
*Wall-mounted crowdcontrol bracket. Matt black color. Belt: 3 or 4 m long.*



## ACCESSORI PER COLONNINE SEGNAPERCORSO CROWDCONTROL POSTS SYSTEM OPTIONS

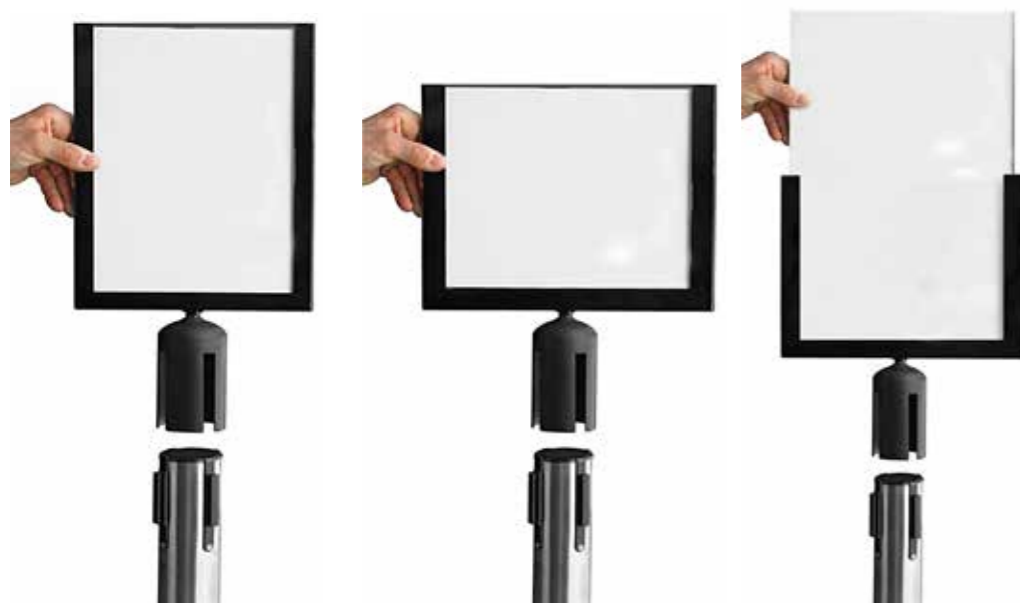

Porta avvisi f.to A4 e f.to A3 con supporto in metallo nero.  
*Brochure holder with black metal support.*

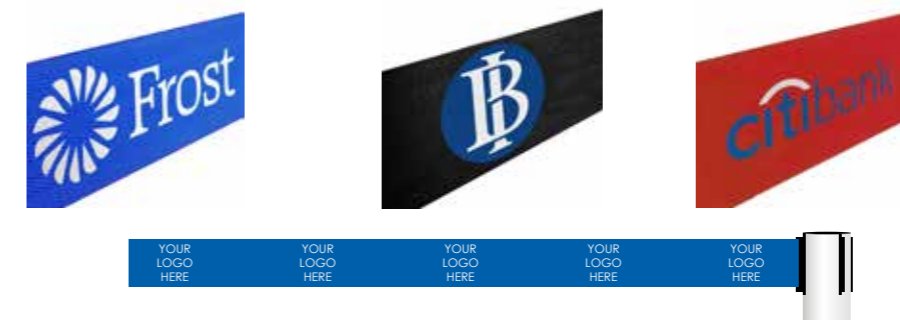

Personalizzazione del nastro con la stampa del proprio LOGO.  
*Customized belt with your LOGO.*

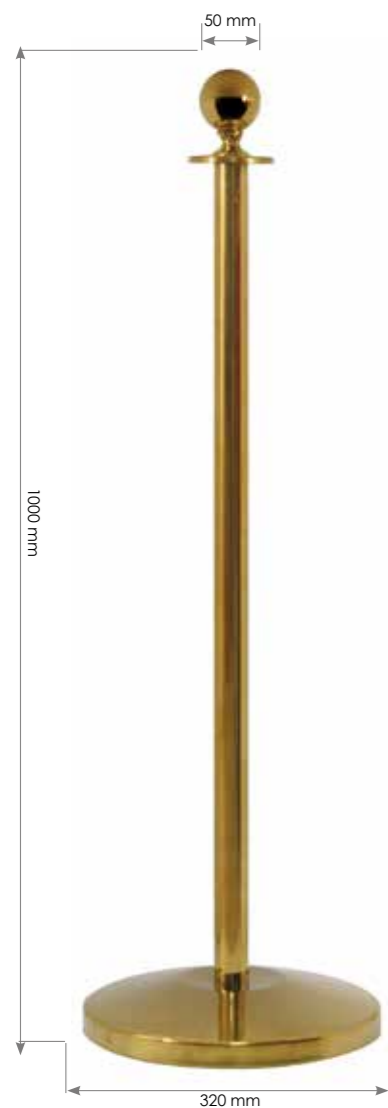

**Colonnine con cordone** in ottone H 100 cm. Finitura cromata gold. Peso totale kg 7,5. Lunghezza cordone 2 m.  
*Stainless steel posts brass finishes. Overall height 100 cm. Gold chrome finishing. Total weight kg 7,5. Cord 2 m long.*

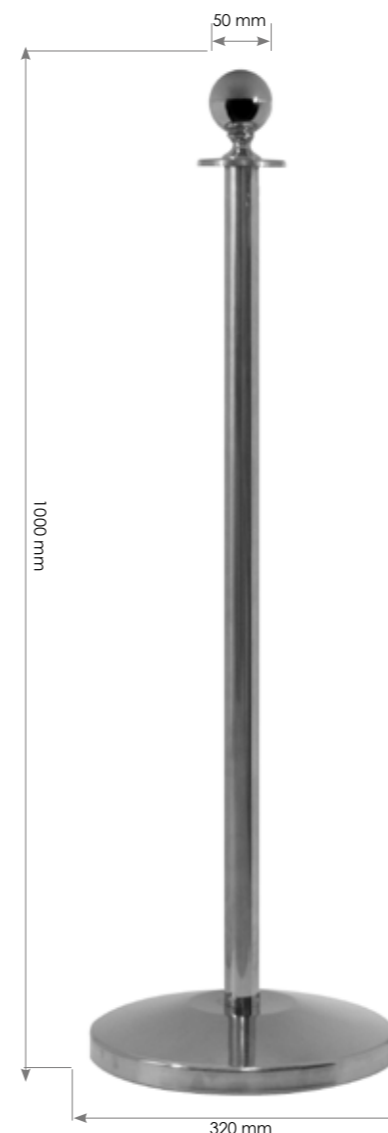

**Colonnine con cordone** in ottone H 100 cm. Finitura cromata silver. Peso totale kg 7,5. Lunghezza cordone 2 m.  
*Stainless steel posts brass finishes. Overall height 100 cm. Silver chrome finishing. Total weight kg 7,5. Cord 2 m long.*





## SUPERFICI DISPONIBILI AVAILABLE SURFACES



Pannello divisorio con superficie in polycarbonato trasparente  
*Dividing panel with surface in transparent polycarbonate*



Pannello divisorio con superficie in polycarbonato bianco  
*Dividing panel with surface in white polycarbonate*

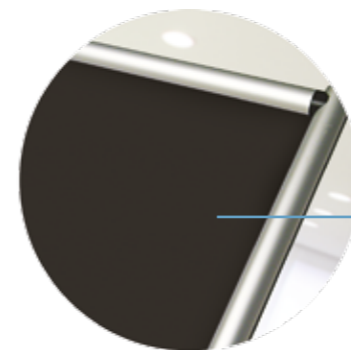

Pannello divisorio con superficie in forex nero stampabile  
*Dividing panel with printable surface in black forex*



Pannello divisorio con superficie in forex bianco stampabile  
*Dividing panel with printable surface in white forex*



Pannello divisorio con superficie magnetica e scrivibile  
*Dividing panel with magnetic and writable surface*

## PANNELLI DIVISORI DIVIDING PANELS



# ESPOSITORI PORTA DEPLIANT LITERATURE STANDS



Porta avvisi con crowner personalizzabile formato A4.  
*A4 communications stand with customized crowner.*

Porta depliant ad una tasca formato A5.  
*Literature stand with one A5 poket.*



Porta depliant multipli.  
*Literature stand in different formats.*



# ESPOSITORI PORTA DEPLIANT LITERATURE STANDS



Leggio in plexi trasparente  
*Bookrest in plexi*

Montante in alluminio anodizzato color silver  
*Silver anodized aluminium post*



Superficie in plexi  
*Table surface in plexi*

Montante in alluminio anodizzato color silver  
*Silver anodized aluminium post*



Superficie in plexi  
*Table surface in plexi*

Doppio montante in alluminio anodizzato color silver  
*Silver anodized aluminium double post*



## ESPOSITORI PORTA DEPLIANT LITERATURE STANDS



Struttura mono o bifacciale  
*One or two-side stand*

Tasche in plexi  
*Pockets in plexi*

Base fissa o girevole  
*Fixed or swivel base*

Colori versione trasparente  
*Colors transparent version*



Colori versione coprente  
*Colors non-transparent version*



## ESPOSITORI PORTA DEPLIANT LITERATURE STANDS

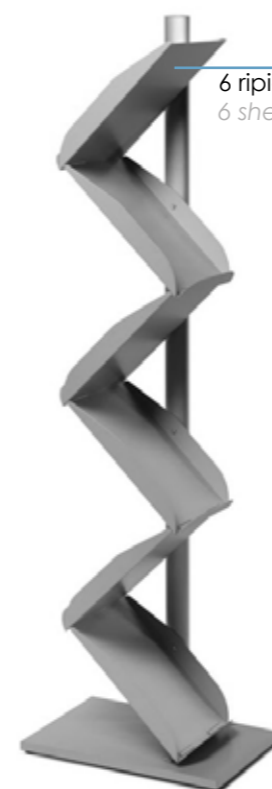

6 ripiani f.to A4  
*6 shelves din A4*



Cornice bifacciale  
f.to A3  
*Double side crown  
er din A3*

3 ripiani f.to A4  
*3 shelves din A4*





# ESPOSITORI PORTA DEPLIANT LITERATURE STANDS



Montante in alluminio anodizzato silver a sezione ovale  
*Oval anodized aluminium post color silver*

Tasche in plexi o in lamiera microforata formato A4.  
*Pockets in plexi or in perforated metal foil A4*

Vela in plexi satinato personalizzabile  
*Printable panel in satinized plexi*

Montante in alluminio anodizzato silver a sezione ovale  
*Oval anodized aluminium post color silver*

Tasche in plexi o in lamiera microforata formato A4.  
*Pockets in plexi or in perforated metal foil A4*

I ripiani portaoggetti sono in plexi  
*Shelves are available in plexi*

Montante in alluminio anodizzato silver a sezione ovale  
*Oval anodized aluminium post color silver*

Vela in plexi satinato personalizzabile  
*Printable panel in satinized plexi*



# ESPOSITORI PORTA DEPLIANT LITERATURE STANDS



Ripiani inclinabili o utilizzabili in orizzontale.  
*Inclinable shelves or usable in horizontal.*

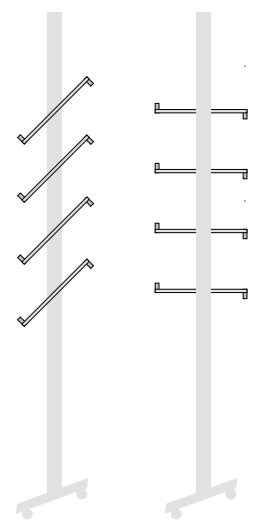



## PORTA TABLET TABLET KIOSK

SUPPORTI PER IPAD  
FREESTANDING FOR IPAD



SUPPORTO PER TABLET  
FREESTANDING FOR TABLET

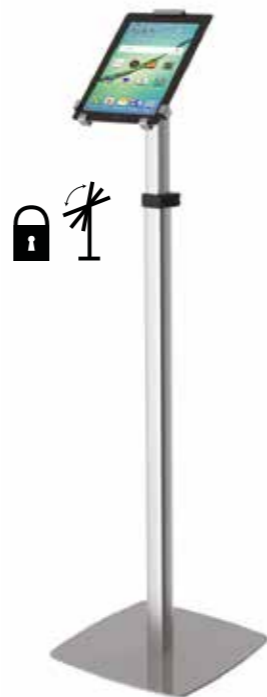

## PORTA TABLET DA PARETE E DA TAVOLO WALL-MOUNT AND DESK TABLET STAND

SUPPORTO PER TABLET  
FREESTANDING FOR TABLET



SUPPORTI PER IPAD  
FREESTANDING FOR IPAD





Punto di Isola & C. sas

Ufficio amministrativo e vendite - Showroom 1  
Administrative and sales office - Showroom 1  
Via Vizza, 45 - 31018  
Gaiarine (TV) ITALY

Ufficio legale - Deposito - Showroom 2  
Legal head office - Warehouse - Showroom 2  
Via Provinciale, 2 - 35010  
Campo San Martino (PD) ITALY

Tel +39 0434 754040 - Fax +39 049 9630431  
[www.velasystem.com](http://www.velasystem.com) - [info@velasystem.com](mailto:info@velasystem.com)